

BRAVAD FREESTANDING KITCHEN

DESIGN:

Mikael Warnhammar

MATERIALS:

Solid oak, oak veneer and stainless steel. Door/drawer fronts in white painted fibreboard with integrated handles and legs in aluminium.

FINISH:

The units are clear lacquered and the countertops have been treated with oil for a more hard-wearing and durable surface.

CARE & MAINTENANCE:

The countertops have been factory-treated with one coat of oil. Treating countertops with BEHANDLA wood treatment oil 3-5 times a year preserves the durable surface for many years. Clean stainless steel surfaces after use by wiping with a sponge and clean cloth, adding a little dishwashing detergent if necessary. Always wipe lengthways.



This symbol means you have a limited 10-year quality and durability warranty on your IKEA kitchen. Read more in the warranty brochure.

ENVIRONMENTAL INFORMATION:

BRAVAD is made of solid wood. This is a good material both from the point of view of quality and with regard to the environment. Wood is a renewable resource. It is also recyclable and bio-degradable. None of our solid wood products are made from timber taken from intact natural forests.

SPECIAL ASSEMBLY INFORMATION:

To prevent toppling, all cabinets should be anchored to the wall or the floor.

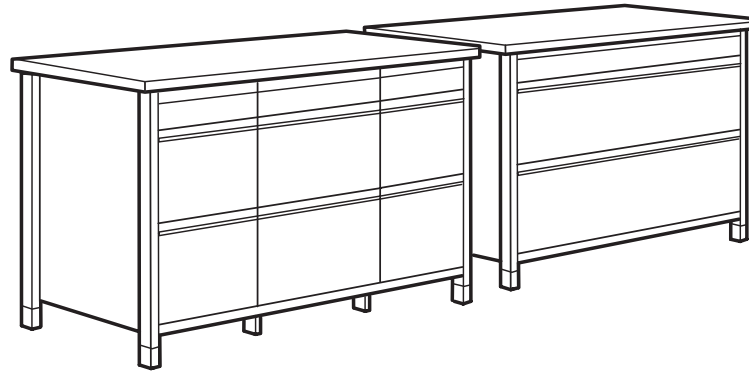
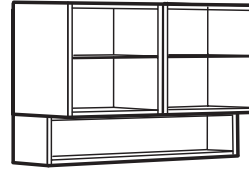

BRAVAD freestanding kitchen is a fast and simple way to a flexible kitchen. Three complete, all-in-one units are all you need to cover your basic kitchen needs: cooking, washing up and storing. The freestanding units are just like any other piece of furniture – easy to plan for and easy to buy. They're also easy to arrange in the room. And just as easy to move when you want to rearrange the room, or to take with you if you move house. Smart. And easy!

Cabinets in BRAVAD freestanding kitchen have smooth-running drawers that you can open all the way. That gives you an overview of what's inside and means you won't have to stretch to reach things right at the back. All drawers have an inbuilt damper to ensure that they close slowly, quietly and softly. The drawers are made of hardwearing wood with a bottom of scratch-resistant white melamine. Quality through and through, in other words.

The all-in-one units in BRAVAD freestanding kitchen are made of hardwearing solid oak and horizontal oak veneer. White-lacquered drawer fronts with integrated aluminium handles serve to reinforce the clean, contemporary design. Even the oiled countertops are solid oak and measure a full 26" (67 cm) deep. That gives you a work surface that's both generous and robust. If you want to make use of the walls, you can complement with wall cabinets and/or open wall shelves. You can even use extra shelves to make use of the space between base cabinets. What freedom!



Design and Quality
IKEA of Sweden

WHY BRAVAD?

Drawers that pull out further. Fully extending drawers give you more usable space and easier access to everything stored inside. That makes preparing food much simpler.

Make full use of corners to maximise storage and work space. The corner base cabinet has smooth-running, fully extending drawers for easy access to all you need – all the way to the back.

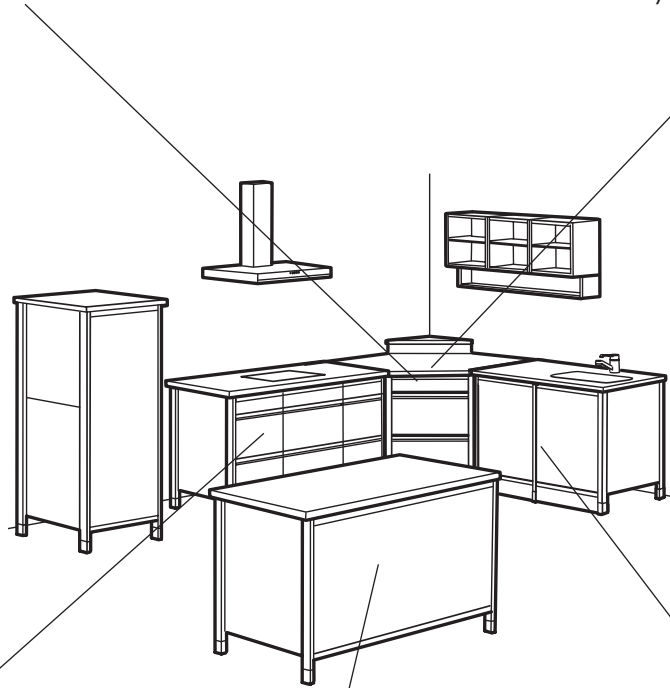

Organise the contents in deep drawers exactly as you wish with adjustable dividers. It's the simple way to make the best possible use of your drawer space – and it makes kitchen work simpler, too.

An attractive, durable, white back panel makes base cabinets ideal in an island kitchen. More work space for preparing food and more storage space for your utensils. Simply remember to secure the cabinet to the floor.

The sink cabinet is designed to hold a fully-integrated dishwasher on either the right or left-hand side, depending on where you choose to place the reversible sink. There is no predrilled hole so you can place your faucet where it suits you best.

BRAVAD SOLUTIONS

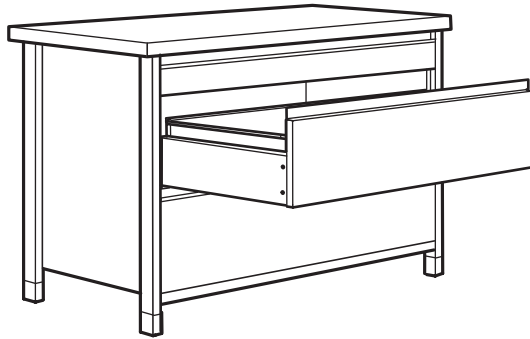

Hidden feature slows it down. All drawers in BRAVAD free-standing kitchen are equipped with inbuilt dampers to cushion the closing action and to ensure that the drawer closes slowly, softly and quietly – regardless of how much force you use, or what you have inside. Beauty comes from within, they say. It's so true.

Base cabinet 52x35" (132x90 cm) \$529

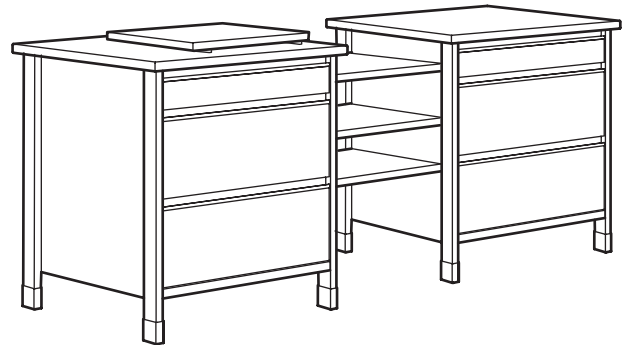

Use the space between cabinets. Mount BRAVAD shelves between the base cabinets and what you get is practical storage for the things you want within easy reach. And the top shelf can also serve as an extra work surface. Or as a stable chopping board if you choose to use it loose on the counter.

This combination \$937

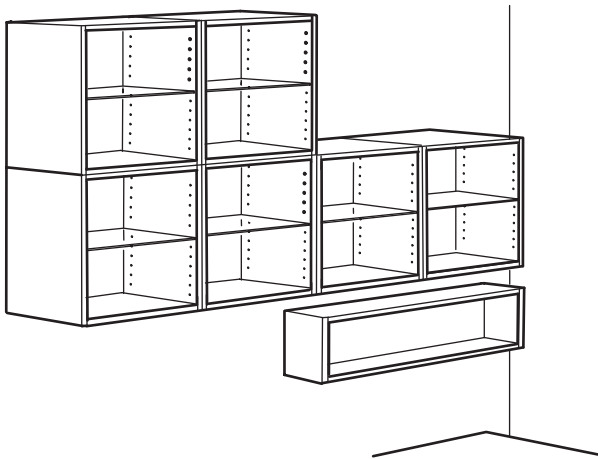











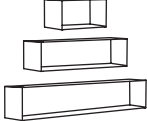
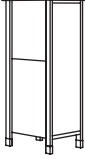

Combine as you like. We made the wall shelves and wall cabinet in the BRAVAD series in sizes that allow you to customise your very own wall solution. The look is open and airy. And a good tip is to mount a wall shelf a bit below the wall cabinet – that gives you an extra shelf into the bargain.

This combination \$340

BRAVAD ALL THE PARTS, SIZES AND PRICES

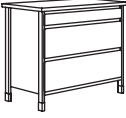
All cabinets have smooth-running, fully extending drawers with drawer stops and integral drawer dampers to cushion the closing action and close drawers quietly and gently. Adjustable legs stand steady on uneven surfaces too. Appliances sold separately.
Width x Depth x Height.

	DIMENSIONS	ARTICLE NUMBER	PRICE	QUANTITY/TOTAL		DIMENSIONS	ARTICLE NUMBER	PRICE	QUANTITY/TOTAL
	Base cabinet with countertop. Oak/oak veneer/white. Fully-extending drawers. May be completed with dividers for deep drawer, cutlery tray, chopping board or tray from the RATIONELL series.					Base cabinet. Oak/oak veneer/white. May be completed with e.g. dividers for deep drawer W15¾" (40 cm), cutlery tray, chopping board or tray from the RATIONELL series.			
	Frame Xx26¾x35¾" (152x67x90 cm)	600.995.12	\$669			20½x26¾x35¾" (52x67x90 cm)	900.995.15	\$379	
	Countertop Xx26¾x35¾" (152x67x90 cm)	200.995.09	\$189			Wall cabinet. Oak veneer/grey. 1 adjustable tempered glass shelf; adjust according to your storage needs.			
	Sink cabinet with single bowl sink. Oak/oak veneer/white. Reversible sink in stainless steel; can be used with the bowl to the right or left. Sound-absorbent material. There is no predrilled hole in the sink, giving you a free choice of placing the kitchen faucet. To make holes FIXA 2-piece tool set can be recommended, sold separately.					Glass-door wall cabinet. Oak veneer/white. 1 adjustable tempered glass shelf; adjust according to your storage needs. The tempered glass door can be mounted to open left or right. Handle included.			
	Frame 53x26¾x35¾" (135x67x90 cm)	501.104.40	\$399			20x18x14" (50x35x46 cm)	300.995.23	\$4999	
	Single Bowl Sink 53x26¾x35¾" (135x67x90 cm)	701.104.39	\$150			Wall shelf. Oak veneer/grey.			
	High cabinet with high door. Oak/oak veneer/white. 4 fully-extending drawers with high front and back edges to keep the things stored in place. Door with wide opening angle 155° makes the contents easy to reach. The door can be mounted to open from the left or right.					20x7x9" (50x18x23 cm)	800.995.25	\$2999	
	21x26x58" (52x67x148 cm)	400.995.13	\$599			39x7x9" (100x18x23 cm)	500.995.22	\$3999	
	Corner base cabinet. Oak/oak veneer/white. Provides storage and work space in the corner as well. May be completed with, for example, dividers for deep drawer W23½" (60 cm), cutlery tray, chopping board or tray from the RATIONELL series.					59x7x9" (150x18x23 cm)	700.995.21	\$5999	
	45x50x35" (113x126x90 cm)	100.995.19	\$699			Desk top/shelf. To be mounted between the BRAVAD base cabinets to make the most of the unused space. The top can be fitted between BRAVAD base cabinets, or used separately as a chopping board. Oiled solid oak; can be sanded and surface treated as required.			
	Base cabinet. Oak/oak veneer/white.					20x26" (50x67 cm)	200.995.14	\$179	
	52x26¾x35¾" (132x67x90 cm)	700.995.16	\$529			Worktop. Oiled solid oak; can be cut to length, sanded and surface treated as required.			
	Base cabinet. Oak/oak veneer/white. May be completed with RATIONELL dividers for deep drawer W31½" (80 cm).					60x26x1" (152x67x3 cm)	200.995.09	\$189	
	36¼x26¾x35¾" (92x67x90 cm)	800.995.11	\$499			Single bowl sink. Reversible sink in stainless steel; can be used with the bowl to the right or left. Sound-absorbent material. There is no predrilled hole in the sink, giving you a free choice of placing the kitchen faucet. To make holes FIXA 2-piece tool set can be recommended, sold separately.			
	Base cabinet. Oak/oak veneer/white. May be completed with e.g. dividers for deep drawer W23½" (60 cm), cutlery tray, chopping board or tray from the RATIONELL series.					53x26x1" (135x67x3 cm)	701.104.39	\$150	
	28¾x26¾x35¾" (72x67x90 cm)	900.995.20	\$419						